



Spraytech[®]
 Systems (India) Pvt. Ltd.
The Flow Technologists

Cleaning-In-Place (CIP) Spray Nozzles



CLEANING-IN-PLACE (CIP)

APPLICATION

- Beverage industry
- Bioengineering
- Chemical industry
- Cosmetic industry
- Food industry
- Pharmaceutical industry
- Tank building and many others...

Tank Washing Spray Nozzles Selection

Overview

In this section a brief elaboration will clear the concept of spray nozzles selection for requirement and there various factors which affects and plays vital role in extent of cleaning required.

Following some factors should well studied when selecting CIP spray nozzles.

1) Extent of Cleaning

The nature of substance to be cleaned from tank should be considered like, solubility, viscosity, nature of powder / pigment material.

Based on all this factors we can decide which type of impact is necessary to flush substance from all internals of equipment.

- a) Rinsing : By virtue mass removal of substance and thick layers get dissolved by water or solvent
- b) Cleaning : After rinsing cleaning could be done with high pressure to remove rest of the residue from internal.
- c) High Impact Cleaning : Those substances which could not be satisfactory cleaned by means of cleaning cycle, should be treated with high pressure of cleaning fluid.
- d) Sanitizing : Sanitize chemical is applied after cleaning to kill microorganisms and bacteria.
- e) Disinfecting : Same procedure is applied for disinfectant
- f) Sterilizing : It kills all kinds of bacteria.

Heat energy's role

Viscosity of fluids decreases with increasing temperature so, effective cleaning can be achieved by using hot cleaning fluids or by increasing temperature of vessel tank by means of steam jackets. By virtue of this viscosity of substances to be cleaned decrease and effective cleanliness increases.

Spray Pattern

If cleaning is done manually then stationery spray nozzles are recommended to use. Ex. Flat spray nozzle, Straight jet spray nozzle, Full cone spray nozzle. For CIP self rotating spray nozzles gives droplets spray to clean the substances. For higher tank sizes tank cleaning machine is recommended as it gives cyclic control speed of rotation which provide the high impact jet cleaning with long impact distances.

Obstructions due to internals

If tank is having any central agitation / mixing arrangement then multiple spray nozzle should be utilized.

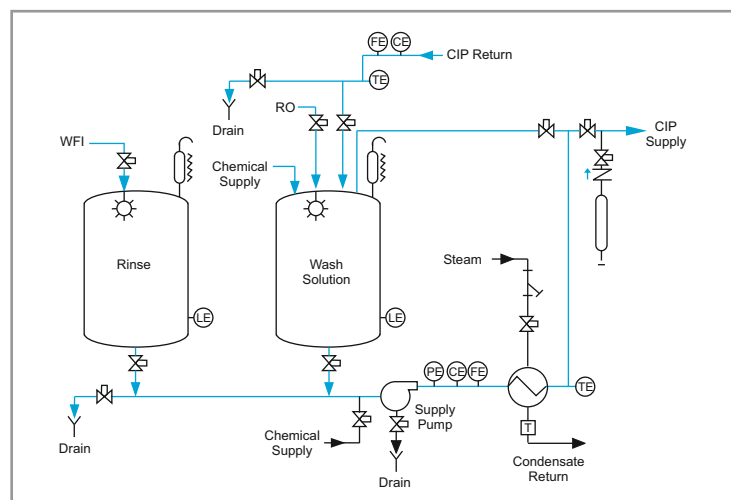

Cleaning-In-Place (CIP)

Fully or semi-automated, integrated cleaning technique that allows to clean closed or open circuits without dismantling equipments

Standard CIP sequence

Alkaline cleaning	To eliminate organic trace elements
Rinsing	To push out caustic
Acid cleaning	To eliminate mineral deposits
Rinsing	To push out acid
Disinfection	To kill / inactivate micro-organisms
Rinsing	To eliminate CIP chemicals and prepare the line for production

Single-use system

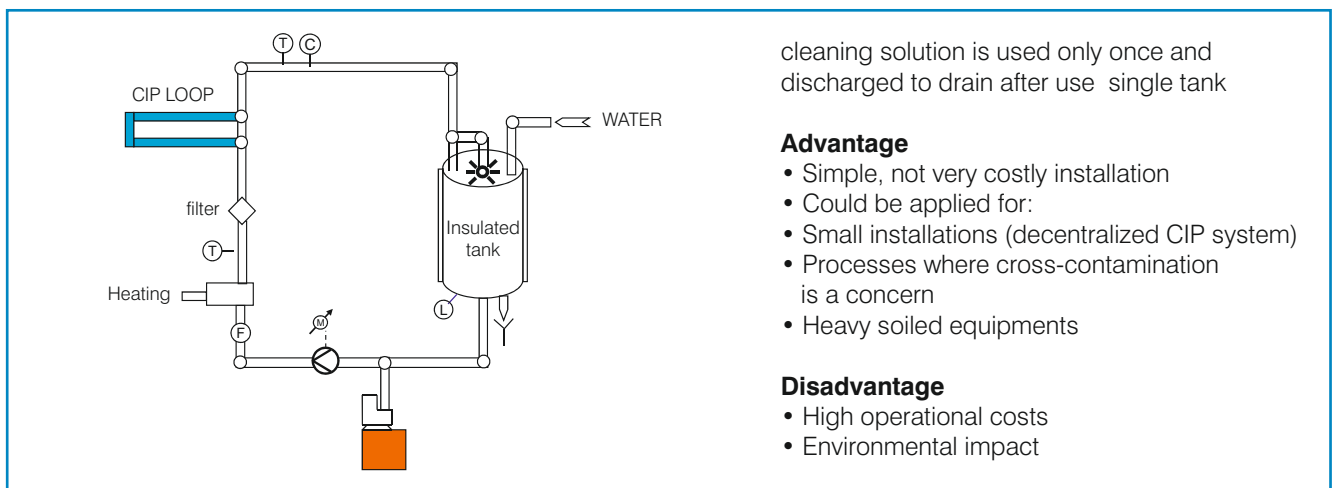

Re-use system

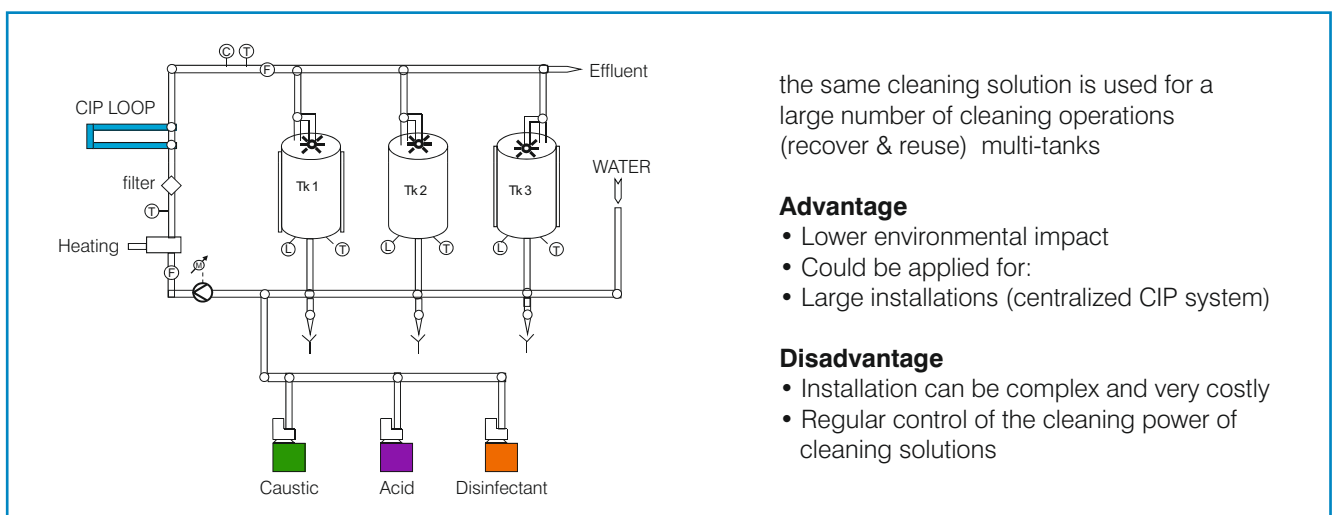

Spraytech Product Coding System

The following description will help to explain our Part Number/ Code in relation to the "SPRAYTECH" Spray Nozzle.

EXAMPLE ORDERING.

SPRAYTECH EA 1 A

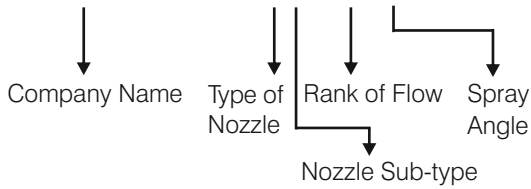

096

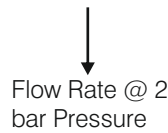

M2

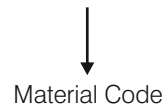

Y B

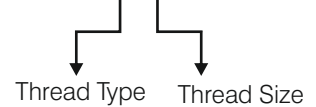

Codes	Spray Nozzles Type
A	Air Atomizing /Fine Atomizing Spray Nozzle
B	Hollow Cone Spray Nozzle
C	Flat Spray Nozzle
D	Full Cone Spray Nozzle
E	Tank Washing Spray Nozzle
F	Steel Mill Spray Nozzles
G	General Engineering & Accessories
H	Special Project

Codes	Thread Size
A	1/8"
B	1/4"
C	3/8"
D	1/2"
E	3/4"
F	1"
G	1 1/4"
H	1 1/2"
K	2"
L	2 1/2"
M	3"
N	3 1/2"
O	4"

Nozzle Sub-type (see table overleaf)

Spray Angle Code	Spray Angle	Coverage Type
A	180°	
B	180°	
C	270°	
D	270°	
E	360°	

Note : special size on request























Code	Material
M0	M.S.
M1	SS303/SS304/ M1L = SS304L
M2	SS316/ M 2L = SS316L
M3	Brass
M4	SS410
M4-3	SS310
M5	Cast Iron
M6	Aluminum
M7	Hastelloy C/B /2000
M8	Titanium
M9	Monel
P1	PVC(Polyvinylchloride)
P2	PP (Polypropylene)
P3	Teflon®/ PTFE (Polyterafluoroethylene)
P4	Nylon(Polyamide)
P5	Delrin®/ POM (Polyacetate)
P6	PVDF(Polyvinylidene fluoride)
P7	Polyethylene

Note : Special material on request

Codes	Thread Type
X	BSPP
Y	BSPT
Z	NPT

Note : special Connection on request

Self-rotating / Stationery Tank Cleaning Nozzles

Nozzle Type	Series	Spray Angle	Flow rate LPM @ 2 bar	End Connection	ATEX Certified	Specification
	EA	180° ↓ 270° ↓ 360°	10-40	1/4" 3/8" 1/2" Tri-Clover End		Features: Compact design suitable for Cleaning small vessel/tanks Cleaning Diameter: Upto 1.5 M Type: Self - rotating. MOC: SS304, SS316, TEFLON
	EB	180° ↓ 270° ↓	18-38	1/2" Tri-Clover End		Features: Compact design suitable for Cleaning small vessel/tanks Cleaning Diameter: Upto 1.5 M Type: Self - rotating. MOC: SS304, SS316
	EC	270° ↑↓ 360°	32-250	1/2" 3/4" 1", 1 1/2", 2" Pin connection Tri-Clover End		Features: Jet type spray pattern, Best suitable For Glass lined reactors Cleaning Diameter: Upto 2.5 M Type: Self - rotating. MOC: SS304, SS316, TEFLON
	ED	270° ↑↓ 360°	32-160	3/4" Pin connection Tri-Clover End		Features: Flat spray tips for high impact cleaning, Cleaning Diameter: Upto 2.5 M Type: Self - rotating. MOC: SS304, SS316
	EE	180° ↑↓ 270° ↑↓ 360°	140-1100	1" 1 1/2" 2" 3" Tri-Clover End		Features: Best suitable for Large vessels, High impact cleaning with maximum reach Cleaning Diameter: Upto 4 M Type: Self - rotating. MOC: SS304, SS316
	EF	180° ↑↓ 360°	40-140	3/4" 1" Tri-Clover End		Features: Unique rotating disc design. Best suitable for FBD, FBP, FBC Cleaning Diameter: Upto 2 M Type: Self - rotating. MOC: SS304, SS316
	EG	270° ↑↓ 360°	15-200	3/8" 1/2" 3/4" 1" 1 1/4" Pin connection Tri-Clover End		Features: Double sided bearing for effortless rotation Best suitable for SS reactors, Pharmaceutical Vessels Cleaning Diameter: Upto 2.5 M Type: Self - rotating. MOC: SS304, SS316
	EH	180° ↓ 270° ↓	18-100	3/8" 1/2" Tri-Clover End Pin connection		Features: Uni body design Multiple orifice for high impact jet spray, Cleaning Diameter: Upto 1.5 M Type: Stationary MOC: SS304, SS316, TEFLON
	EI	180° ↓ 270° ↓ 360°	100-500	3/4" to 2" Pin connection Tri-Clover End		Features: Uni body design, Multiple jet spray with high flow Cleaning Diameter: Upto 2.5 M Type: Stationary MOC: SS304, SS316
	EJ	180° ↑↓ 270° ↑↓ 360°	15-100	3/8" 1/2" Tri-Clover End Pin connection		Features: Uni body compact design, Multiple jet spray for 360° cleaning Cleaning Diameter: Upto 1.5 M Type: Stationary MOC: SS304, SS316, TEFLON
	EK	 270°	20-40	Tri-Clover End		Features: Unique retractable type pop up nozzle Best suitable for isolators Cleaning Diameter: Upto 1 M Type: Self - rotating, Retractable MOC: SS304, SS316

* Note: All Connections are available in BSP, BSPT, NPT.

* ↑:Upward Spray ↓:Downward spray.

EA Self-Rotating Spray Nozzles Stainless Steel & Plastic Versions

EA

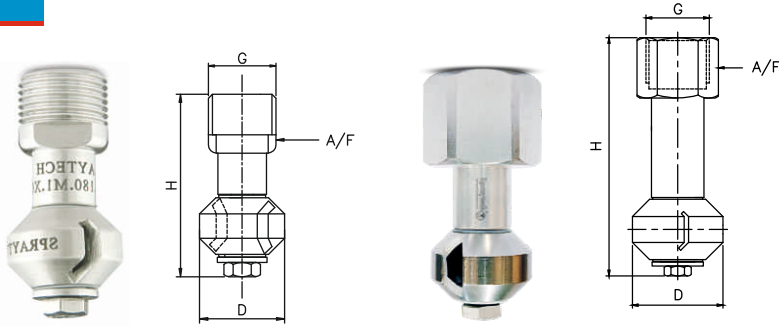

EA series nozzles are very compact and designed for cleaning process in small bore or small size of containers. The rotary motion allows it to clean the vessels effectively. It is available in all grade of stainless steel material and also available in plastics like PTFE along with several spray angles.

Coverage Type	Spray Angle
B	180°
D	270°
E	360°

MODEL NO.	SPRAY ANGLE	CONNECTION			FLOW CAPACITY IN LPM AT DIFFERENT PRESSURE					CONNECTION	G/A DIMENSION. MM					
		1/4"	3/8"	1/2"	PRESSURE [BAR]						MALE			FEMALE		
					1.5	2	3	5	7		H	D	A/F	H	D	A/F
EA2.100	B/D/E	●			8.66	10.00	12.25	15.81	18.71	1/4"	45	16	12.8	45	16	16
EA2.120	B/D/E	●	●		10.39	12.00	14.70	18.97	22.45	Weight (Metals) = XX gms. Approx						
EA2.150	B/D/E		●		12.99	15.00	18.37	23.72	28.06	3/8"	45	22.2	12.8	51	22.2	22
EA2.180	B/D/E		●		15.59	18.00	22.05	28.46	33.67	Weight (Metals) = 30.0 gms. Approx						
EA2.220	B/D/E		●	●	19.05	22.00	26.94	34.79	41.16	1/2"	79	30	22	79	30	24
EA2.300	B/D/E			●	25.98	30.00	36.74	47.43	56.12	Weight (Metals) = XX gms. Approx						
EA2.350	B/D/E			●	30.31	35.00	42.87	55.34	65.48							
EA2.400	B/D/E			●	34.64	40.00	48.99	63.25	74.83							

End Connection : X – BSP, Y - BSPT, Z – NPT Available.

Female Connection On Request

EB Self-Rotating Spray Nozzles Stainless Steel Versions

EB

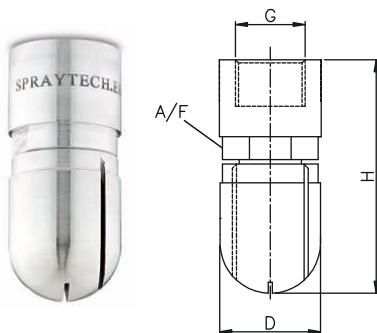

EB series self rotating nozzles are designed as a small dimensions and opening and perform inside cleaning which is required. Typically used for cleaning like kegs, small container where the requirement is for cleaning. Diameter of nozzle is (25mm) These nozzles are available in all grade of stainless steel.

Male Connection On Request

Coverage Type	Spray Angle
B	180°
D	270°

MODEL NO.	SPRAY ANGLE	CONNECTION	FLOW CAPACITY IN LPM AT DIFFERENT PRESSURE					G/A DIMENSION. MM			
		1/2"	PRESSURE [BAR]								
			1.5	2	3	5	7	CONN.	H	D	A/F
EB2.180	B/D	●	15.59	18.00	22.05	28.46	33.67	1/2"	55	24.2	21
EB2.220	B/D	●	19.05	22.00	26.94	34.79	41.16	Weight (Metals) = XX gms. Approx			
EB2.280	B/D	●	24.25	28.00	34.29	44.27	52.38	1/2"	55	24.2	21
EB2.320	B/D	●	27.71	32.00	39.19	50.60	59.87	Weight (Metals) = XX gms. Approx			
EB2.380	B/D	●	32.91	38.00	46.54	60.08	71.09				

End Connection : X – BSP, Y - BSPT, Z – NPT Available.

EC Self-Rotating Spray Nozzles Stainless Steel & Plastic Versions



Specially designed self rotating nozzle, rotates because of reaction principle of spraying water jets. For rinsing small and medium sized vessels for example dairy, chemical, pharmaceutical and food industries. Material of construction- corrosion – resistance PTFE. (Range available from 1/2" to 2")

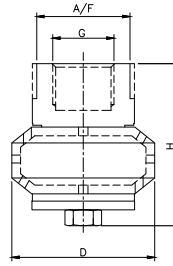

Metal Versions

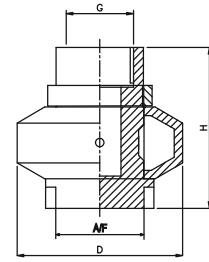

Plastic Versions



Male Connection On Request

Coverage Type	Spray Angle
	270°
	270°
	360°

End Connection :
X – BSP,
Y - BSPT,
Z – NPT Available.

MODEL NO.	SPRAY ANGLE	CONNECTION					FLOW CAPACITY IN LPM AT DIFFERENT PRESSURE					M1/M2	P3/P4		
		1/2"	3/4"	1"	1 1/2"	2"	PRESSURE [BAR]					SS304/SS316	TEFLON/NYLON		
							1.5	2	3	5	7	G/A DIMENSION. MM			
												CONN.	H	D	A/F
EC2.320	C/D/E	●					27.71	32.00	39.19	50.60	59.87	1/2"	60	50	28.6
EC2.400	C/D/E	●	●				34.64	40.00	48.99	63.25	74.83	Weight (Metals) = XX gms. Approx			
EC2.520	C/D/E	●	●	●			45.03	52.00	63.69	82.22	97.28	3/4"	68	58.5	32
EC2.720	C/D/E		●	●			62.35	72.00	88.18	113.84	134.70	Weight (Metals) = XX gms. Approx			
EC2.950	C/D/E		●	●			82.27	95.00	116.35	150.21	177.73	1"	76.2	78.5	42
EC3.120	C/D/E		●	●	●		103.92	120.0	146.97	189.74	224.50	Weight (Metals) = XX gms. Approx			
EC3.140	C/D/E		●	●	●		121.24	140.0	171.46	221.36	261.92	1 1/2"	92	92	55
EC3.150	C/D/E			●	●		138.56	160.0	195.96	252.98	299.33	Weight (Metals) = XX gms. Approx			
EC3.190	C/D/E				●	●	164.54	190.0	232.70	300.42	355.46	2"	111	124	66
EC3.225	C/D/E				●	●	194.54	225.0	275.57	355.76	420.94	Weight (Metals) = XX gms. Approx			
EC3.250	C/D/E				●	●	216.51	250.0	306.19	395.28	467.71				

ED Barrel Tank Washing Spray Nozzles Stainless Steel Versions



Suited for CIP systems. No motor source is needed due to the reaction force of the cleaning liquid to rotate spray head. Low pressure for cleaning and rinsing application. For rinsing small and medium sized vessels for example dairy, chemical, pharmaceutical and food industries.

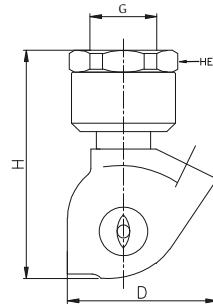

Male Connection On Request

Coverage Type	Spray Angle
	270°
	270°
	360°

End Connection :
X – BSP,
Y - BSPT,
Z – NPT Available.

MODEL NO.	SPRAY ANGLE	CONNECTION	FLOW CAPACITY IN LPM AT DIFFERENT PRESSURE					G/A DIMENSION. MM		
			PRESSURE [BAR]							
			1.5	2	3	5	7	CONN.	H	D
		3/4"								
ED2.320	C/D/E	●	27.71	32.00	39.19	50.60	59.87	3/4"	100	70
ED2.520	C/D/E	●	45.03	52.00	63.69	82.22	97.28	Weight (Metals) = 95.0 gms. Approx		
ED2.720	C/D/E	●	62.35	72.00	88.18	113.84	134.70			
ED2.950	C/D/E	●	82.27	95.00	116.35	150.21	177.73			
ED3.120	C/D/E	●	103.92	120.0	146.97	189.74	224.50			
ED2.140	C/D/E	●	121.24	140.0	171.46	221.36	261.92			
ED3.160	C/D/E	●	138.56	160.0	195.96	252.98	299.33			

EE Gyro Jet Tank Washing Spray Nozzles Stainless Steel Versions

EE

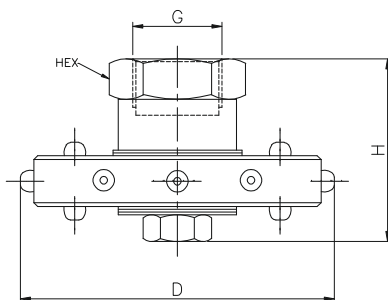

Self powered rotating tank cleaning nozzle used for cleaning large and medium size diameter tanks. Efficient cleaning action for medium and large size tanks. Recommended operating pressure 2 to 3 kg/cm² and also available coverage 180° (up and down), 270° (up and down) and 360°.

Coverage Type	Spray Angle
A	180°
B	180°
C	270°
D	270°
E	360°

MODEL NO.	SPRAY ANGLE	CONNECTION				FLOW CAPACITY IN LPM AT DIFFERENT PRESSURE					G/A DIMENSION. MM			
		1"	1 1/2"	2"	3"	PRESSURE [BAR]					CONN.	H	D	HEX
						1.5	2	3	5	7				
EE3.140	A/B/C/D/E	●				121.24	140	171.46	221.36	261.92	1"	62.5	117	41
EE3.160	A/B/C/D/E	●				138.56	160	195.96	252.98	299.33	Weight (Metals) = 771.0 gms. Approx			
EE3.200	A/B/C/D/E	●				173.21	200	244.95	316.23	374.17	1 1/2"	97	131	71
EE3.250	A/B/C/D/E	●				216.51	250	306.19	395.28	467.71	Weight (Metals) = 1930gms. Approx			
EE3.275	A/B/C/D/E		●			238.16	275	336.80	434.81	514.48	2"	116.5	194	100
EE3.325	A/B/C/D/E		●	●		281.46	325	398.04	513.87	608.02	Weight (Metals) = 3630gms. Approx			
EE3.375	A/B/C/D/E		●	●		324.76	375	459.28	592.93	701.56	3"	XX	XX	XX
EE3.500	A/B/C/D/E			●		443.01	500	612.37	790.57	935.41	Weight (Metals) = XX gms. Approx			
EE4.625	A/B/C/D/E			●		541.27	625	765.47	988.21	1169.27				
EE3.800	A/B/C/D/E				●	692.82	800	979.80	1264.91	1496.66				
EE3.950	A/B/C/D/E				●	822.72	950	1163.51	1502.08	1777.29				
EE4.1100	A/B/C/D/E				●	952.63	1100	1347.22	1739.25	2057.91				

End Connection : X – BSP, Y - BSPT, Z – NPT Available.

Male Connection On Request

EF Turbo Cleaning Spray Nozzles Stainless Steel Versions

EF

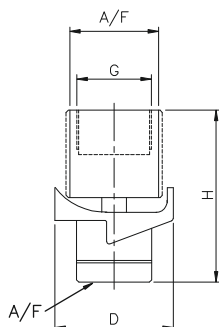

The turbo nozzles are generally used for washing of industrial storage tanks small barrels and used in the dairy, chemical, pharmaceutical, food industries and process industries. The rotating Disc dispense an instant powerful dense spray to all the interior surface of the vessels. Spray coverage 180° up and down 360°.

Coverage Type	Spray Angle
A	180°
B	180°
E	360°

MODEL NO.	SPRAY ANGLE	CONNECTION		FLOW CAPACITY IN LPM AT DIFFERENT PRESSURE					G/A DIMENSION. MM			
		3/4"	1"	PRESSURE [BAR]					CONN.	H	D	A/F
				1.5	2	3	5	7				
EF2.400	A/B/E	●		34.64	40.00	48.99	63.25	74.83	3/4"	74	51	38
EF2.520	A/B/E	●		45.03	52.00	63.69	82.22	97.28	Weight (Metals) = 460 gms. Approx			
EF2.720	A/B/E	●	●	62.35	72.00	88.18	113.84	134.70	1"	74	51	38
EF2.950	A/B/E	●	●	82.27	95.00	116.35	150.21	177.73	Weight (Metals) = 460 gms. Approx			
EF3.120	A/B/E		●	103.92	120.0	146.97	189.74	224.50				
EF3.140	A/B/E		●	121.24	140.0	171.46	221.36	261.92				

End Connection : X – BSP, Y - BSPT, Z – NPT Available.

Male Connection On Request



EG Series Slotted spray ball series are available with different connection design that it is a female thread and clip-on connection as standard. Weld-on or tri-clamp connection on request. The simple design high quality construction and having a good efficiency and applicable for general purpose application and it is available in coverage of 270° up and down and 360°.

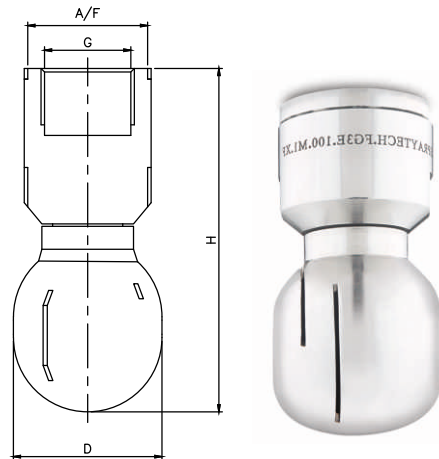

Coverage Type	Spray Angle
	270°
	270°
	360°

MODEL NO.	SPRAY ANGLE	CONNECTION							FLOW CAPACITY IN LPM AT DIFFERENT PRESSURE					G/A DIMENSION. MM		
		1/8"	1/4"	3/8"	1/2"	3/4"	1"	1 1/4"	PRESSURE [BAR]					CONN.	H	D
									1.5	2	3	5	7			
EG2.100	C/D/E	●							8.66	10.00	12.25	15.81	18.71	1/8"	37	17
EG2.150	C/D/E	●	●	●					12.99	15.00	18.37	23.72	28.06	1/4"	48	21.5
EG2.200	C/D/E	●	●	●					17.32	20.00	24.49	31.62	37.42	Weight (Metals) = XX gms. Approx		
EG2.250	C/D/E			●	●				21.65	25.00	30.62	39.53	46.77	3/8"	60	27
EG2.300	C/D/E			●	●				25.98	30.00	36.74	47.43	56.12	Weight (Metals) = XX gms. Approx		
EG2.350	C/D/E			●	●				30.31	35.00	42.87	55.34	65.48	1/2"	77	33
EG2.400	C/D/E			●	●	●			34.64	40.00	48.99	63.25	74.83	Weight (Metals) = XX gms. Approx		
EG2.520	C/D/E				●	●			45.03	52.00	63.69	82.22	97.28	3/4"	98	41
EG2.600	C/D/E					●			51.96	60.00	73.48	94.87	112.25	Weight (Metals) = XX gms. Approx		
EG2.700	C/D/E					●			60.62	70.00	85.73	110.68	130.96	1"	104	47.5
EG2.800	C/D/E					●	●		69.28	80.00	97.98	126.49	149.67	Weight (Metals) = XX gms. Approx		
EG2.900	C/D/E					●	●		77.94	90.00	110.23	142.30	168.37	1 1/4"	119	58
EG3.100	C/D/E						●	●	86.60	100.0	122.11	158.11	187.08	Weight (Metals) = XX gms. Approx		
EG3.110	C/D/E						●	●	95.26	110.0	134.72	173.93	205.79			
EG3.120	C/D/E						●	●	103.92	120.0	149.97	189.74	224.50			
EG3.130	C/D/E						●	●	112.98	130.0	159.22	205.55	243.21			
EG3.140	C/D/E						●	●	121.24	140.0	171.46	221.36	261.92			
EG3.150	C/D/E						●	●	129.90	150.0	183.71	237.17	280.62			
EG3.160	C/D/E							●	138.56	160.0	195.96	252.98	299.33			
EG3.170	C/D/E							●	147.22	170.0	208.21	268.79	318.04			
EG3.180	C/D/E							●	155.88	180.0	220.45	284.60	336.75			
EG3.190	C/D/E							●	164.54	190.0	232.70	300.42	355.46			
EG3.200	C/D/E							●	173.21	200.0	244.95	316.23	374.17			

End Connection : X – BSP, Y - BSPT, Z – NPT Available.

Male Connection On Request

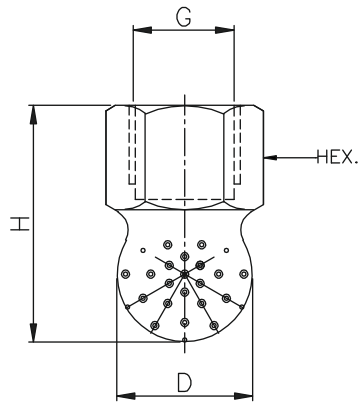

Female Connection

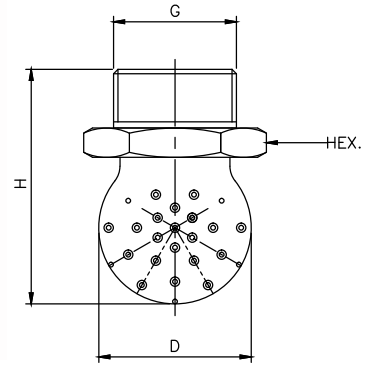

Male Connection

EH Series Static Spray Ball has very compact design that provides straight jets for high impact rinsing of small drums or container up to \varnothing 1.5m. Also it can be used with saturated steam. Spray coverage is available in 180° & 270°

SPRAY ANGLE

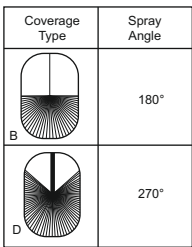

MODEL NO.	SPRAY ANGLE	CONNECTION			FLOW CAPACITY IN LPM AT DIFFERENT PRESSURE					
		1/4"	3/8"	1/2"	FLOW CAPACITY (US GPM)	PRESSURE [BAR]				
						40° psi	1.5	2	3	5
EH1.800	B/D	●			2.45	6.93	8.00	9.80	12.65	14.97
EH2.100	B/D	●			3.09	8.66	10.00	12.25	15.81	18.71
EH2.120	B/D	●			3.71	10.39	12.00	14.70	18.97	22.45
EH2.140	B/D	●			4.33	12.12	14.00	17.15	22.14	26.19
EH2.160	B/D	●			4.90	13.86	16.00	19.60	25.30	29.93
EH2.180	B/D	●	●	●	5.50	15.59	18.00	22.05	28.46	33.67
EH2.220	B/D		●	●	6.32	19.05	22.00	26.94	34.79	41.16
EH2.280	B/D		●	●	8.58	24.25	28.00	34.29	44.27	52.38
EH2.320	B/D		●	●	9.81	27.71	32.00	39.19	50.60	59.87
EH2.400	B/D		●	●	12.38	34.64	40.00	48.99	63.25	74.83
EH2.520	B/D		●	●	15.94	45.03	52.00	63.69	82.22	97.28
EH2.600	B/D			●	18.58	51.96	60.00	73.48	94.87	112.25
EH2.700	B/D			●	21.68	60.62	70.00	85.73	110.68	130.96
EH2.800	B/D			●	24.52	69.28	80.00	97.98	126.49	149.67
EH2.900	B/D			●	27.87	77.94	90.00	110.23	142.30	168.37
EH3.100	B/D			●	30.65	86.60	100.0	122.47	158.11	187.08

End Connection : X – BSP, Y - BSPT, Z – NPT Available.

CONNECTION	1/4"			3/8"			1/2"		
	H	H1	D	H	H1	D	H	H1	D
MALE	32	15	16	35	16.5	17	40	26	27
	Weight (Metals) = XX gms. Approx			Weight (Metals) = XX gms. Approx			Weight (Metals) = XX gms. Approx		
FEMALE	32	15	16	35	21.5	22	45.3	26	27
	Weight (Metals) = XX gms. Approx			Weight (Metals) = XX gms. Approx			Weight (Metals) = XX gms. Approx		

EI Series Static Spray Ball Stainless Steel & Plastic Versions

EI

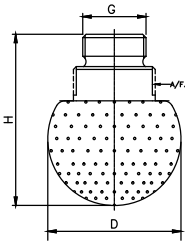

Male Connection

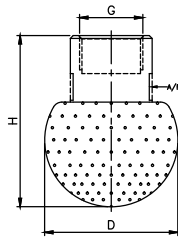

Female Connection

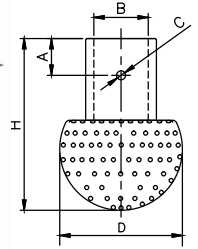

Pin Type Connection

EI Series Static Spray Ball is a newly designed stationary spray ball with multiple orifices. Its unique design helps to cover complete 360 degree with impact type jet sprays. It is available in many sizes and flow rates. Impact type spray helps to remove sticky stains. Also it can be used with saturated steam.

Coverage Type	Spray Angle
	180°
	180°
	270°
	360°

Design features

- Jet type cleaning
- Impact type cleaning
- Can be used for steam applications
- Available in Threaded, Pin type and Tri Clover type end connection
- Available in SS304, SS316, SS316L, Hastelloy C-276, PTFE

Cleaning Diameter up to 2.0 meters

End Connection :

- X – BSP,
- Y – BSPT,
- Z – NPT Available.

MODEL NO.	SPRAY ANGLE	CONNECTION										FLOW CAPACITY IN LPM AT DIFFERENT PRESSURE							
		1/8"	1/4"	3/8"	1/2"	3/4"	1"	1 1/4"	1 1/2"	2"	PRESSURE [BAR]								
											1.5	2	3	5	7				
EI1.650	A/B/D/E	●													5.63	6.50	7.96	10.28	28.06
EI1.800	A/B/D/E	●													6.93	8.00	9.80	12.65	14.97
EI2.100	A/B/D/E	●													8.66	10.00	12.25	15.81	18.71
EI2.125	A/B/D/E	●													10.39	12.50	14.70	18.97	22.45
EI2.140	A/B/D/E	●													12.12	14.00	17.15	22.14	26.19
EI2.160	A/B/D/E	●													13.86	16.00	19.60	25.30	29.93
EI2.180	A/B/D/E	●	●	●	●										15.59	18.00	22.05	28.46	33.67
EI2.220	A/B/D/E	●	●	●	●										19.05	22.00	26.94	34.79	41.16
EI2.280	A/B/D/E		●	●	●										24.25	28.00	34.29	44.27	52.38
EI2.320	A/B/D/E		●	●	●										27.71	32.00	39.19	50.60	59.87
EI2.400	A/B/D/E		●	●	●										34.64	40.00	48.99	63.25	74.83
EI2.520	A/B/D/E		●	●	●										45.03	52.00	63.69	82.22	97.28
EI2.600	A/B/D/E			●	●										51.96	60.00	73.48	94.87	112.25
EI2.700	A/B/D/E				●										60.62	70.00	85.73	110.68	130.96
EI2.800	A/B/D/E				●	●									69.28	80.00	97.98	126.49	149.67
EI2.900	A/B/D/E				●	●									77.94	90.00	110.23	142.30	168.37
EI3.100	A/B/D/E				●	●	●								86.60	100.0	122.47	158.11	187.08
EI3.120	A/B/D/E					●	●								103.92	120.00	149.74	189.74	224.50
EI3.140	A/B/D/E					●	●								121.24	140.00	171.46	221.36	261.92
EI3.160	A/B/D/E						●	●							138.56	160.00	195.96	252.98	299.33
EI3.190	A/B/D/E							●	●						164.54	190.00	232.70	300.42	355.46
EI3.225	A/B/D/E								●	●	●				194.86	225.00	275.57	355.76	420.94
EI3.250	A/B/D/E									●	●	●			216.51	250.00	306.19	395.28	487.71
EI3.275	A/B/D/E										●	●	●		238.46	275.00	336.19	434.81	514.48
EI3.300	A/B/D/E											●	●	●	259.81	300.00	367.42	474.34	561.25
EI3.325	A/B/D/E											●	●	●	281.46	325.00	398.04	513.87	608.02
EI3.350	A/B/D/E												●	●	303.11	350.00	428.66	553.40	654.79
EI3.375	A/B/D/E													●	324.76	375.00	459.28	592.93	701.56
EI3.400	A/B/D/E													●	346.41	400.00	489.90	632.46	748.33
EI3.425	A/B/D/E													●	368.06	425.00	520.52	671.98	795.10
EI3.450	A/B/D/E													●	389.71	450.00	551.14	711.51	841.87

CONNECTION	1/8"			1/4"			3/8"			1/2"			3/4"			1"			1 1/4"			1 1/2"			2"		
DIMENSION	H	D	A/F	H	D	A/F	H	D	A/F	H	D	A/F	H	D	A/F	H	D	A/F	H	D	A/F	H	D	A/F	H	D	A/F
MALE	30	20	12	33.5	22	12	42	30	15	60	40	19	78	55	32	90	70	40	105	80	46	115	90	55	128	100	62
FEMALE	30	20	12	33.5	28	16	50	40	22	55	48	27	78	55	32	90	70	40	105	80	46	115	90	55	128	100	62
	Weight (Metals) = XX gms. Approx			Weight (Metals) = XX gms. Approx			Weight (Metals) = XX gms. Approx			Weight (Metals) = XX gms. Approx			Weight (Metals) = XX gms. Approx			Weight (Metals) = XX gms. Approx			Weight (Metals) = XX gms. Approx			Weight (Metals) = XX gms. Approx			Weight (Metals) = XX gms. Approx		

CONNECTION	DN 8				DN 10				DN 15				DN 20				DN 25				DN 32				DN 40				DN 50											
DIMENSION	H	D	A/F	C	A	H	D	A/F	C	A	H	D	A/F	C	A	H	D	A/F	C	A	H	D	A/F	C	A	H	D	A/F	C	A	H	D	A/F	C	A					
PIN TYPE	32.5	20	8.2	2.2	9	37.5	24	12.2	2.2	9	42	30	18.2	2.2	9	53	40	22.2	2.5	9	90	70	28.2	2.8	18	105	80	-	2.8	18	115	90	-	2.8	18	128	100	52.3	3.3	25

EJ Fixed Tank Washing Spray Nozzles Stainless Steel & Plastic Versions



Suitable for washing of thick kind of materials. Having multiple spray tips on peripheri which can provides upto 360° of spray coverage. Rigid construction. M.O.C SS316, SS304.

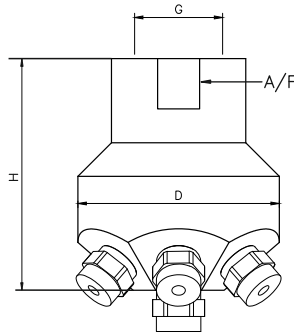

Coverage Type	Spray Angle
A	180°
B	180°
E	360°

MODEL NO.	SPRAY ANGLE	CONNECTION	FLOW CAPACITY IN LPM AT DIFFERENT PRESSURE						G/A DIMENSION. MM	
			FLOW CAPACITY (US GPM)	PRESSURE [BAR]						
				1 1/2"	40° psi	1.5	2	3	5	7
EJ3.100	A/B/E	●	30.65	86.60	100.0	122.47	158.11	187.08	121	127
EJ3.140	A/B/E	●	42.91	121.24	140.0	171.46	221.36	261.92	Weight (Metals) = 1.7kg. Approx	
EJ3.190	A/B/E	●	58.24	164.54	190.0	232.70	300.42	355.46		

End Connection : X – BSP, Y - BSPT, Z – NPT Available.

Male Connection On Request

EK Series Self Rotating Pop-Out Nozzle



EK series Self-retractable (Pop out) nozzles are best suitable for applications where the complete flush position is required. It is generally used the areas where the nozzle can get blocked or when the environment is contaminated or explosive.

EK series Pop out nozzle retracts its spray ball when pressure is applied and shut itself to complete flush position when operation is stopped.

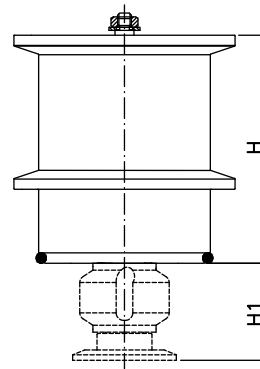

2" TC (DIN32676-A DN50)

Coverage Type	Spray Angle
D	270°

MODEL NO.	SPRAY ANGLE	CONNECTION	FLOW CAPACITY IN LPM AT DIFFERENT PRESSURE					G/A DAIMENTION	
			Tri-Clamp	PRESSURE [BAR]					
				1.5	2	3	5	7	H
EK2.200	D	2" TC	17.32	20.0	24.49	31.62	37.42	66	28
EK2.250	D	2" TC	21.65	25.0	30.62	39.53	46.77	Weight (Metals) = XX Approx	
EK2.300	D	2" TC	25.98	30.0	36.74	47.43	56.12		
EK2.350	D	2" TC	30.31	35.0	42.87	55.34	65.48		
EK2.400	D	2" TC	34.64	40.0	48.99	63.25	74.83		

* Note: Connections are available in threaded and TC end.

EN Series Free Rotating Cleaners

EN

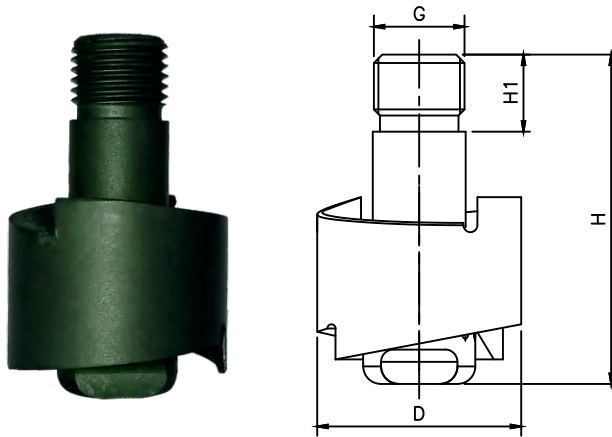

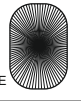
Coverage Type	Spray Angle
	360°

Spraytech EN Series free rotating cleaners The unique ball bearing free design with only one rotating disc instantly generates high speed spherical droplets. Maximum surface coverage is attained by fast travelling sphere of droplets to cover full inside surface of the vessels. The droplets also reach inlet pipes and pipe entry points, where often contamination takes place.

Applications : These Tank washer are compact in design and effective in performance and are suitable for cleaning small/ medium process vessels, storage tanks etc. Where it is required to give longer chemical dwell times for improved cleaning result.

ENA



ENA - PTFE / CPTFE SHAFT & TROLL BALL

MODEL NO.	SPRAY ANGLE	END CONN (G)		FLOW CAPACITY IN LPM AT DIFFERENT PRESSURE					G/A DIMENSION. MM			
		1/4"	3/4"	PRESSURE [BAR]					CONN	H	H1	D
				1.5	2	3	5	7				
ENA2E.400	E	●		34.64	40.00	48.99	63.25	74.83	1/4"	47	11	29
ENA2E.520	E	●		45.03	52.00	63.69	82.22	97.28	3/4"	65	15	39
ENA2E.800	E		●	69.28	80.00	97.98	126.49	149.67	Weight (Metals) = XX kg. Approx			
ENA3E.100	E		●	86.60	100.00	122.47	158.11	187.67				

ENB



ENB - SS16L SHAFT & PTFE TROLL BALL

MODEL NO.	SPRAY ANGLE	END CONN (G)		FLOW CAPACITY IN LPM AT DIFFERENT PRESSURE					G/A DIMENSION. MM			
		1/4"	3/4"	PRESSURE [BAR]					CONN	H	H1	D
				1.5	2	3	5	7				
ENB2E.400	E	●		34.64	40.00	48.99	63.25	74.83	1/4"	47	11	29
ENB2E.520	E	●		45.03	52.00	63.69	82.22	97.28	3/4"	65	15	39
ENB2E.800	E		●	69.28	80.00	97.98	126.49	149.67	Weight (Metals) = XX kg. Approx			
ENB3E.100	E		●	86.60	100.00	122.47	158.11	187.67				

ENC



ENC - SS16L SHAFT & SS316L TROLL BALL

MODEL NO.	SPRAY ANGLE	END CONN (G)		FLOW CAPACITY IN LPM AT DIFFERENT PRESSURE					G/A DIMENSION. MM			
		1/4"	3/4"	PRESSURE [BAR]					CONN	H	H1	D
				1.5	2	3	5	7				
ENC2E.400	E	●		34.64	40.00	48.99	63.25	74.83	1/4"	47	11	29
ENC2E.520	E	●		45.03	52.00	63.69	82.22	97.28	3/4"	65	15	39
ENC2E.800	E		●	69.28	80.00	97.98	126.49	149.67	Weight (Metals) = XX kg. Approx			
ENC3E.100	E		●	86.60	100.00	122.47	158.11	187.67				

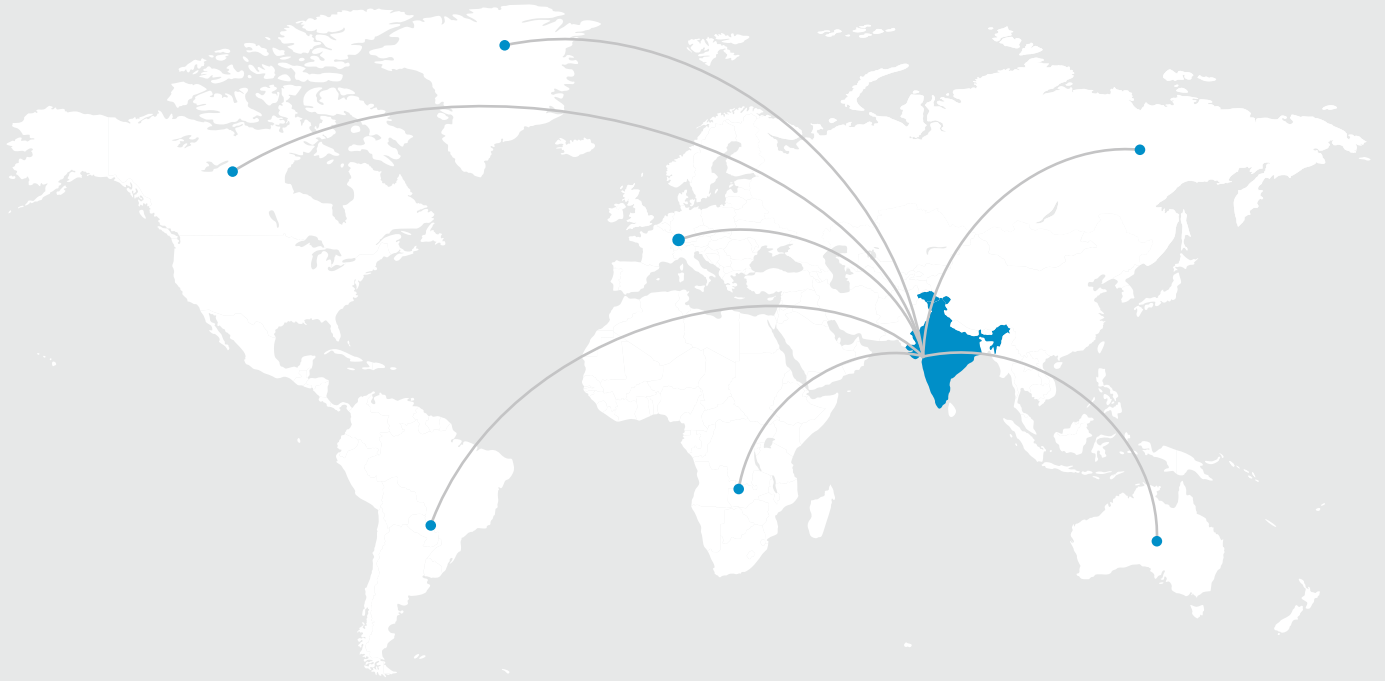

OUR BRANCHES

Regd. Office (Mumbai) :

Spraytech House, Plot A-132, Road No. 23, Spraytech Circle,
Wagle Indl. Estate, Thane (W) - 400 604. Mumbai Maharashtra, (India)
Tel. : 91-022-2582 8929 / 2735 / 2736
E-mail :- sales@spraytechindia.com
sales1@spraytechindia.com

Rabale Plant 1 (Navi Mumbai) :

Spraytech Systems (I) Pvt. Ltd., Plot No.: R-513, MIDC, TTC Industrial
Area, Rabale, Navi Mumbai - 400 701.

Rabale Plant 2 (Navi Mumbai) :

R-446, T.T.C. Industrial Area, MIDC Rabale,
Navi Mumbai - 400 701.

Branch Office (Pune) :

White House, Survey no. 161, Near
Bhosale Garden Hadapsar, Pune 411028

Indapur Plant (Pune) :

Spraytech Systems (I) Pvt. Ltd., Plot No.: A-5, Indapur Five Star
Industrial Area, Village - Loni Devkar Balpudi, Tal. - Indapur,
Dist. - Pune. - 413132

